

This Information Is Provided By
CBTricks.com

SBE SB-M255 Key-com 55 Manual

Liability of damages to any equipment is the sole responsibility of the user! Downloading, viewing, or using any information provided on these pages automatically accepts the user to the terms of this agreement!

Modifications are provided for information purposes only!

Supporters of CBTricks.com paid for the hosting so you would have this file.

CBTricks.com is a non-commercial personal website was created to help promote the exchange of service, modification, technically oriented information, and historical information aimed at the Citizens Band, GMRS (CB "A" Band), MURS, Amateur Radios and RF Amps.

CBTricks.com is not sponsored by or connected to any Retailer, Radio, Antenna Manufacturer or Amp Manufacturer, or affiliated with any site links shown in the links database. The use of product or company names on my web site is not endorsement of that product or company.

The site is supported with donations from users, friends and selling of the Site Supporters DVD's to cover some of the costs of having this website on the Internet instead of relying on banner ads, pop-up ads, commercial links, etc. Thus I do not accept advertising banners or pop-up/pop-under advertising or other marketing/sales links or gimmicks on my website.

ALL the money from donations is used for CBTricks.com I didn't do all the work to make money (I have a day job). This work was not done for someone else to make money also, for example the ebay CD sellers.

All Trademarks, Logos, and Brand Names are the property of their respective owners.

This information is not provided by, or affiliated in any way with any radio or antenna Manufacturers.

Thank you for any support you can give.

For information on how to Support CBTricks.com

<http://www.cbtricks.com/support/>

KEY/COM Fifty-Five

MODEL SB-M255

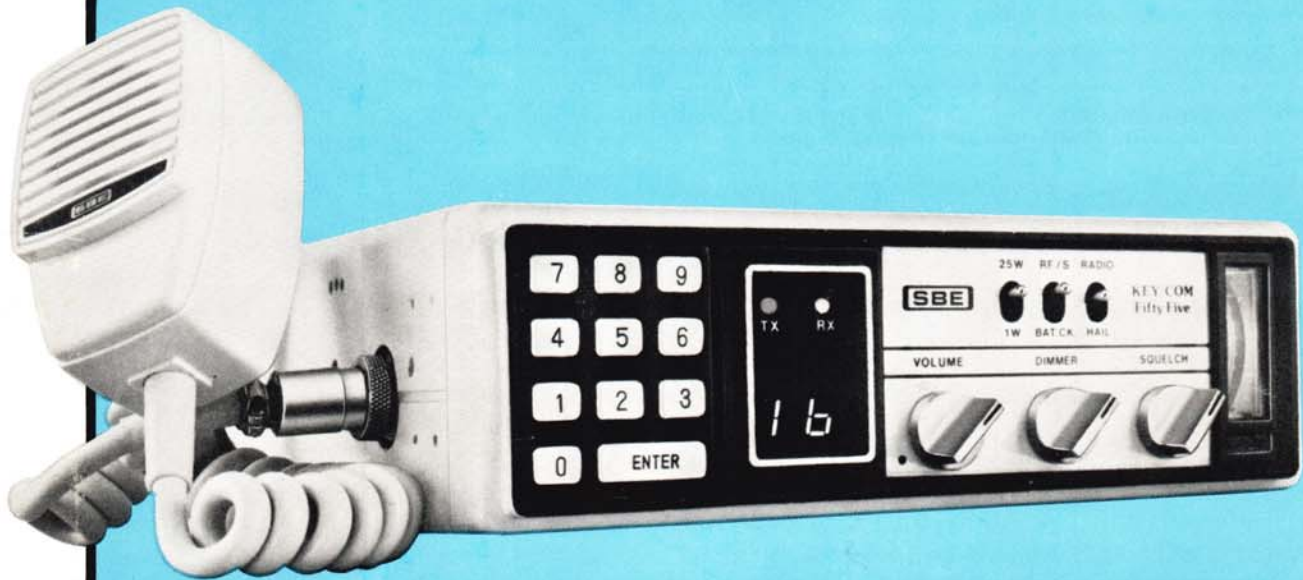

SERVICE MANUAL

SBE

®

TABLE OF CONTENTS

1. GENERAL	3
1.1 Customer Service	3
1.2 Parts Orders	3
1.3 Factory Returns	3
2. INSTALLATION	4
2.1 Mounting Location	4
2.2 Power Connections	4
2.3 Marine Antennas	4
3. SPECIFICATIONS	5
3.1 General	5
3.2 Transmitter	5
3.3 Receiver	6
3.4 Hailer	6
4. CIRCUIT DESCRIPTION	7
4.1 Overview	7
4.2 Automatic RFO Limiter	12
4.3 Transmitter	12
4.4 Receiver	13
5. PERFORMANCE VERIFICATION PROCEDURE	14
6. SERVICING	16
6.1 Troubleshooting with Truth Tables	16
6.2 Alignment	24
7. PARTS LIST	27

BACK POCKET:

SERVICE BULLETINS
PCB TOP SIDE
PCB BOTTOM SIDE
PCB DISPLAY
SCHEMATIC RF SECTION
SCHEMATIC PLL

ILLUSTRATIONS

6-1 PLL Block Diagram	20
6-2 Block Diagram RF Section	21
6-3 Chassis Wiring Diagram	22
6-4 Alignment Layout	22

TABLES

6-1 PLL Truth Table	16
6-2 VCO Frequency Table	17
6-3 PLL Troubleshooting Chart	19

SECTION 1 GENERAL

1.1 CUSTOMER SERVICE

The SBE Technical Services Department functions as a source of information on the application, installation and use of SBE products. In addition, the Technical Services Department provides technical consultation on service problems and availability of local and factory repair facilities.

In any communications to the Technical Services Department, please include a complete description of your problems or needs, including model and serial numbers of the unit or units in question, accessories being used, any modifications or attachments in use, or any non-standard installation details.

For assistance on any of the above matters, please contact SBE, Incorporated, Technical Services Department, 220 Airport Boulevard, Watsonville, California 95076. Phone: 408/722-4177.

1.2 PARTS ORDERS

SBE original replacement parts are available from the Factory Parts Department at 220 Airport Boulevard, Watsonville, California 95076.

When ordering parts, please supply the following information:

- Model number of the unit.
- Serial number of the unit.
- Part number.
- Description of the part.

1.3 FACTORY RETURNS

Repair services are available locally through SBE Certified Service Stations across the country. A list of these Service Stations is available upon request from the Technical Services Department. Do not return any merchandise to the Factory without authorization from the Factory.

SECTION II INSTALLATION

2.1 MOUNTING LOCATION

A location should be chosen for your Key/Com 55 which will provide easy access to the microphone and controls, protection from water, and permit cabling for power and antenna. The Key/Com 55 is designed so that it can be mounted on any rigid surface, such as, a bulkhead, overhead, or console.

2.2 POWER CONNECTIONS

Connect the (red) positive lead directly to the positive terminal of the boat's battery or positive terminal of fuse block. Connect the (black) negative lead of the unit directly to the negative terminal of the battery or negative terminal of fuse block. If additional primary power wire is needed, select the appropriate wire size as follows:

#14, stranded for runs of 10 feet or less.

#12, stranded for runs of 10 feet to 20 feet.

#10, stranded for runs of 20 feet to 30 feet.

2.3 MARINE ANTENNAS

Any of the commonly used 50 ohm marine VHF antennas will give good results for this unit. Keep in mind that the range of your unit can be substantially increased by mounting the antenna at the highest possible location or by use of a higher gain antenna. The dealer from which you purchased the radiotelephone can advise you of the best antenna/mounting configuration for a particular installation.

If the length of cable needed for your installation is greater than that supplied with the antenna, it is recommended that RG-8/U Cable be used.

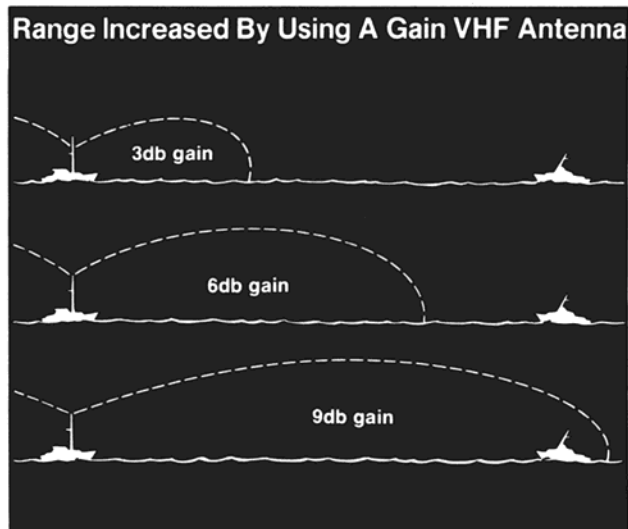

SECTION III SPECIFICATIONS

3.1 GENERAL

Channels	82
Mode	39 Channels for receive only 43 channels for duplex and simplex
Frequency Range	153 MHz to 163 MHz
Frequency Control	Digital Synthesized
Frequency Tolerance	0.001% or better
Operating Temperature Range	-20° C to 50° C
Humidity	95%
Microphone	Dynamic w/ptt switch and coil cord
Input Voltage Range	11.7 to 17 VDC negative ground
Specified Voltage	All operating specifications are at 13.8 VDC unless noted otherwise
Current Drain	Transmit: 25W: less than 6A 1W: less than 2A squelch: less than 0.6A full audio: less than 1A
Size	2-3/4" H (70mm), 7-3/4" W (200mm), 9-1/4" D (235mm)
Weight	4-3/4 lbs. (2.16K)
Antenna Connector	UHF, SO-239

3.2 TRANSMITTER

Power Output	25 watts, switchable to 1 watt
Modulation	PM, ± 5 kHz - 16F3
Modulation Limiting	Instantaneous @ 100%
Audio Response	6db/octave pre-emphasis 300—2500 Hz, +1 -3db
Audio Roll Off	Better than 18db/octave above 3 kHz
Spurious and Harmonic Radiated Outputs	At least 60db below rated carrier power.
Hum and Noise Level	At least 45db below rated carrier output.

3.3 RECEIVER

Input Impedance	50 Ω
IF Frequencies	16.9 MHz, 455 kHz
Sensitivity	0.35 μ v for 12db SINAD
Squelch Sensitivity	0.3 μ V or better
Audio Output	4.5 watts @ 10% distortion
Spurious Response	70db or better

3.4 HAILER

Audio Output	4.5 w @ 10% distortion 4 Ω speaker
--------------	---

SECTION 4 CIRCUIT DESCRIPTION

4.1 OVERVIEW

The Key/Com Fifty-Five incorporates both analog and digital circuitry. The "conventional" RF, IF and AF stages or COMMUNICATIONS is analog while the FREQUENCY SYNTHESIZER and CHANNEL SELECTOR are digital. All logic except the NC6400 chip is TTL except for diodes and gates. While the NC6400 is nMOS, its inputs and outputs are TTL compatible by means of pull up resistors. This logic is located on dual-in-line chips that operate on 4.8 to 5.4 volts. "High", "true" or "logic one" is defined as greater than 2 volts while "low", "false", or "zero" is defined as less than 0.8 volts.

TTL inputs act as highs when unconnected. Normally TTL outputs go high and low without the need for external circuitry. Open collector outputs, however, require an external resistor going to Vcc to pull the output high. The INVERTERS in IC Q403, a 74S05, are open collector and require pull-up resistors R405, R404, R402, R403 and R406.

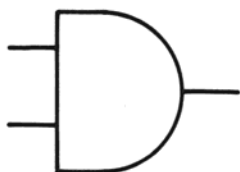

AND Gate
All inputs must be high for a high output.

Diode AND gates are used in the CHANNEL SELECTOR of the Key/Com Fifty-Five COUNTER.

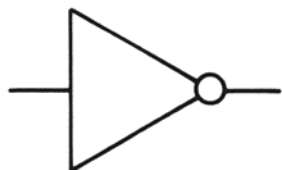

INVERTER
High input—low output.
Low input—high output.

Inverters are used extensively throughout both the FREQUENCY SYNTHESIZER and CHANNEL SELECTOR of the Key/Com Fifty-Five.

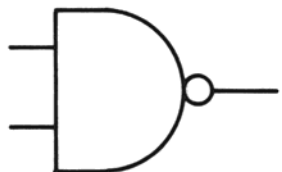

NAND Gate
All inputs must be high for a low output.

NAND gates are used extensively throughout both the FREQUENCY SYNTHESIZER and CHANNEL SELECTOR of the Key/Com Fifty-Five. While most of the NAND gates in the Key/Com Fifty-Five are TTL ICs, Diode-Transistor logic NAND gates are formed by discrete diodes and transistors.

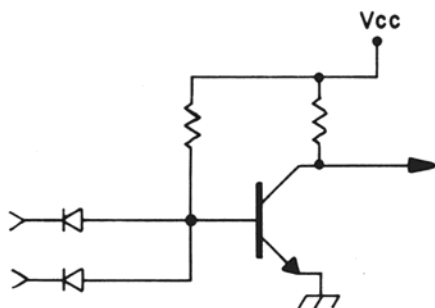

DIODE-TRANSISTOR NAND Gate

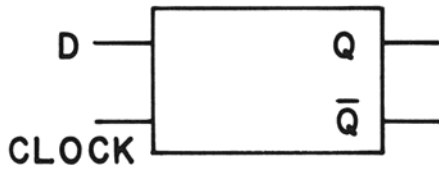

D-FLOP
 State of D input is transferred to Q output as clock input goes from low to high.

If the \bar{Q} output of a D-FLOP is connected to the D input, the Q and \bar{Q} will change states on every other clock pulse. The flop will "toggle" or divide-by-two, that is, it will put one pulse out Q or \bar{Q} for every two clock pulses. Two D-FLOPS are cascaded to form a divide-by-four in the Key/Com Fifty-Five.

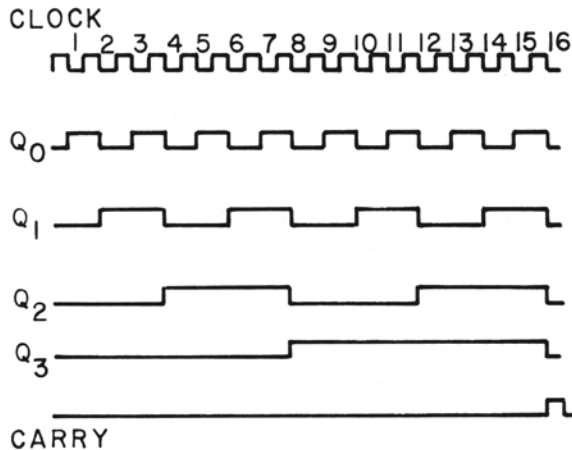
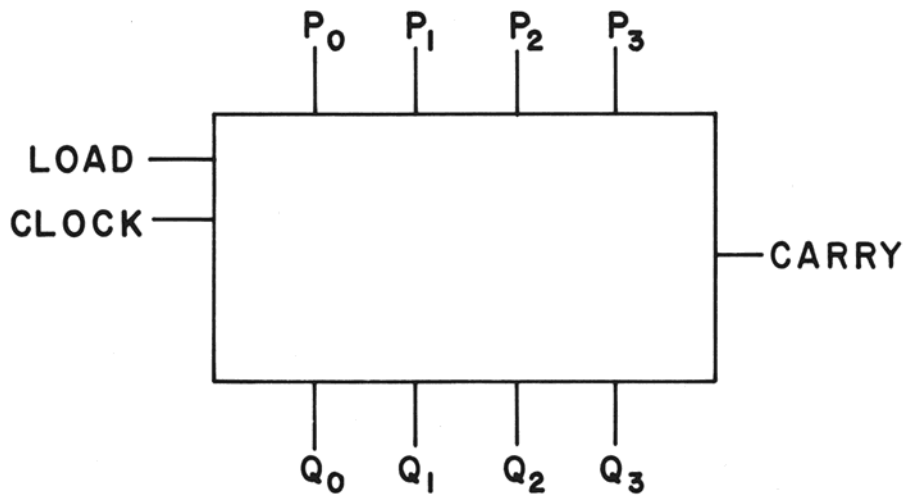

Each positive pulse causes Q_0 to change states. Every other pulse changes Q_1 etc. (See chart at left.)

PRESET COUNTERS can be loaded by pulsing the Preset Enable (PE) input. P_0 , P_1 , P_2 , P_3 preset inputs then appears on the respective Q outputs. Counting then begins at this preset number.

A binary preset counter is used in the Key/Com Fifty-Five SYNTHESIZER. The number of counts achieved before a counter repeats is called its modulus. A 4-bit binary counter, without being reset to zero nor being preset, will have a modulus of 16 (2^4). Q402, a 93S16, is a 4-bit counter in which the modulus is changed by bringing high or low P_0 . Since P_1 , P_2 , P_3 are tied to ground, P_0 low presets 0000 making the modulus 16, while P_0 high presets 0001 making the modulus 15.

A ROM (READ ONLY MEMORY) is a logic network having a defined set of output for each set of inputs. ROMs are incorporated on the NC6400 chip to provide the inputs to the programmable divider in response to channels entered by the keyboard logic and the DOMESTIC/INTERNATIONAL input (pin 25). ROM outputs are provided (pins 19, 20 and 21) to drive logic external to the NC6400 chip.

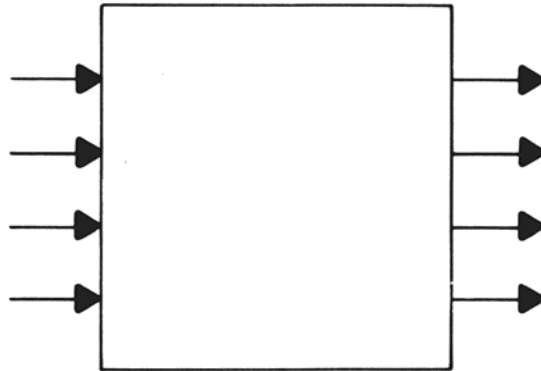

DECODER

A decoder is a logic network which produces defined output for each set of inputs. Decoders are used in the Key/Com Fifty-Five to switch the Tx local oscillator (16.9 or 12.3) and activate the flasher in response to the NC6400 ROM output and the DOMESTIC/INTERNATIONAL strap. These decoders are formed of NAND gates and INVERTERS.

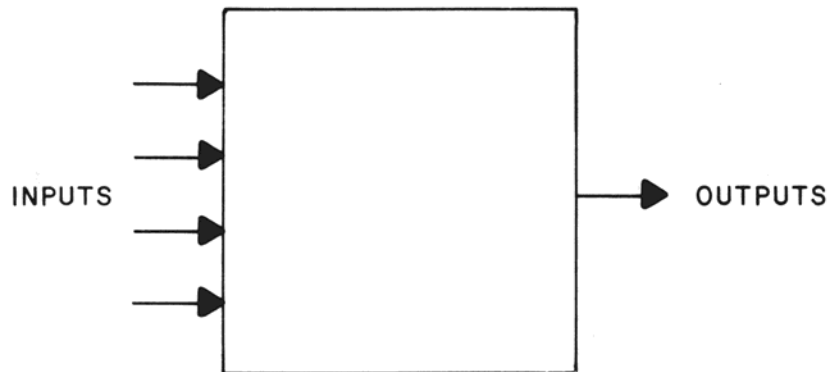

KEYBOARD MATRIX

Columns of the KEY/COM Fifty-Five keyboard are scanned in sequence.

When a key is depressed, connection is made from one column circuit to one row circuit which detects the scanning pulse. This particular combination of row and column identifies the key.

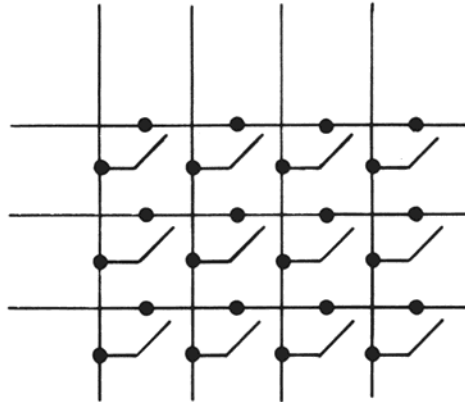

The KEY/COM Fifty-Five employs a digital phase-lock-loop frequency synthesizer to develop all of its transmit and receive frequencies from one crystal. Phase Lock Loop (PLL) means that a **Voltage Controlled Oscillator (VCO)** is held in phase lock to a reference signal by feedback from a phase comparator. A digital PLL frequency synthesizer is formed by inserting a divide-by-N **PROGRAMMABLE DIVIDER** between the VCO and the **PHASE COMPARATOR**. The VCO must then oscillate at N times the reference frequency to keep the output of the divider in lock.

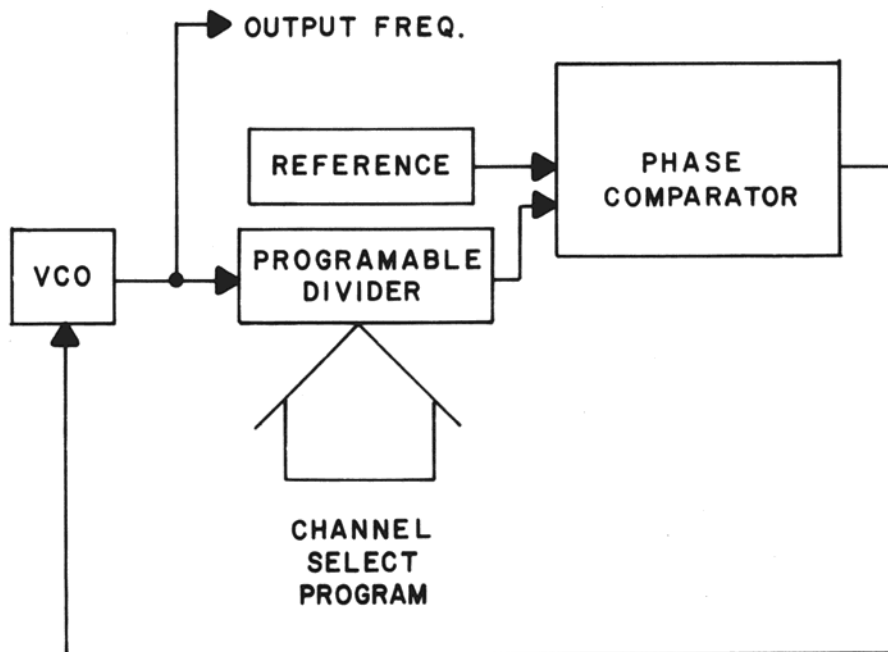

The band separation between VCO frequencies is thus equal to the REFERENCE frequency. Usually the REFERENCE signal is generated by dividing a stable crystal oscillator operating around 1 MHz.

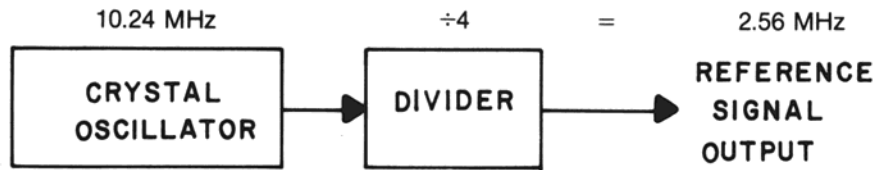

REFERENCE SIGNAL GENERATOR

Most of the Key/Com Fifty-Five SYNTHESIZER, as well as the key scanning and LED display logic, is located on the NC6400 MOS chip. While MOS logic permits compactness and power economy because of its low power consumption and dissipation, it is not capable of operating at the VHF frequencies utilized in the Key/Com Fifty-Five. To overcome this limitation, the PLL utilizes a bipolar prescaler and a VCO external to the MOS chip. Also, the output of the VCO in the Key/Com Fifty-Five is multiplied by 5 to produce the 1st RX L.O.

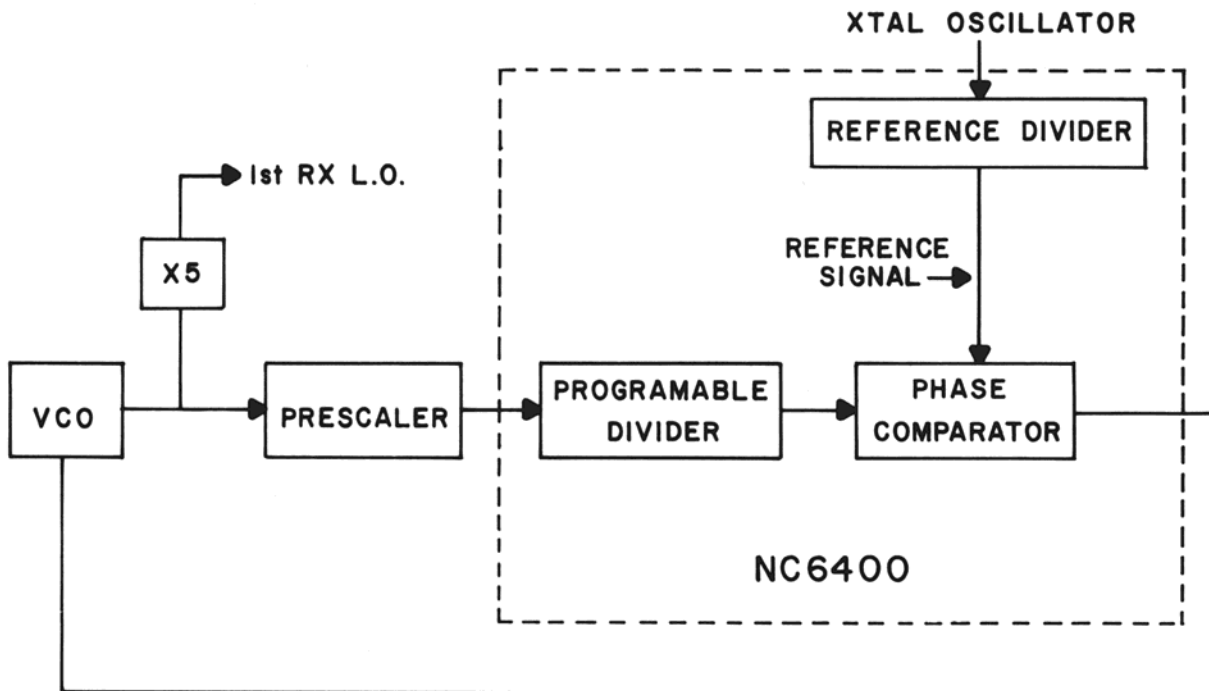

With a fixed (non-programmable) PRESCALER divider, the VCO will oscillate at $M \cdot N$ times the reference frequency. Since M is constant, the VCO band separation will equal $M \cdot (\text{REFERENCE})$. The X5 multiplier in the Key/Com Fifty-Five multiplies the VCO frequencies as well as its band separation by 5 to produce the Rx and Tx frequencies. Since several cycles of reference signal must be sampled by the comparator to lock the VCO, the frequency of the reference signal must be in the kHz range to insure fast loop response, thus it cannot be lowered to accommodate band separation. A DUAL MODULUS PRESCALER (DMP) achieves fractional division by switching between an integer divide-by M and -by $M+1$ to get some divide-by $M+$ (fraction). Fractional steps between integers of the prescaler results in fractional steps in that band separation that would have resulted from just a fixed integer modulus prescaler.

The Key/Com Fifty-Five uses a 93S16 (Q402) presetable 4-bit binary counter as a PRESCALER. Preset inputs P_1 , P_2 , P_3 , (pins 4, 5 and 6), are tied to ground to enter 0s into the counter. Preset P_0 is controlled by the NC6400 chip output R_s (pin 26, NC6400). When R_s is high, a 1 (binary 0001) is entered into the counter and a terminal count of 8 (binary 1000) occurs when Q3 (pin 11, 93S16) goes high after 7 clock pulses. When R_s is low, 8 clock pulses are required to drive Q3 high. The Key/Com Fifty-Five PRESCALER thus has either a modulus of 15 or 16 as controlled by the R_s output of the NC6400 (pin 26).

DIMMER

DIMMER CONTROL, VR303, is located in the feedback circuitry of voltage regulator loop Q11, Q10 and Q9. Incandescent lamps LM301 to 304 are driven from the emitter of Q10. The Q10 emitter also feeds the darlington multiplexer Q507, Q506, Q508, and Q505 which control the common anode voltage on the 7-segment displays.

4.2 AUTOMATIC RFO LIMITER

The RFO limiter regulates the gain of Q3—a TX AMP—to maintain proper output power in response to the 1W/25W switch and 1W and 25W adjustment pots. It also protects the TX FINAL from antenna mismatch. Diode D2 samples output power in accordance with switch position of the 1W/25W switch SW303 and 1W and 25W adjustment pots VR5 and VR6 respectively. The sampled output of D2 is then fed to 1st SAMPLE AMP Q17, Q18, and Q19, to the 2nd SAMPLE AMP Q20, the 3rd SAMPLE AMP Q21 and then to the FINAL SAMPLE AMP Q22, which controls the gain of Q3 by raising and lowering Q3's B+.

4.3 TRANSMITTER

GENERAL

The output of the VOLTAGE CONTROLLED OSCILLATOR is fed to Q41—the VCO BUFFER—and then to varactor diodes D24 and D25 where it is phase modulated. The modulated signal is then fed to Q42 which multiplies its frequency by 5. The x5 signal is then buffed by Q43 and fed to Q6. Q6 mixes the x5 signal with the output of either Q7 or Q8 depending on the decoded ROM signals from the PLL IC. Q7, the 12.3 MHz oscillator, is selected for duplex, and Q8, the 16.9 MHz oscillator is selected for simplex. The output of Q6 is fed to TX BUFFER Q5, TX AMPs Q4 and Q3, TX DRIVER Q2 and TX FINAL Q1.

HAIL

DPDT switch SW304 in RADIO position applies 9V from the TX BUS to MIC amplifier string Q38, Q39, and Q40 and directs the output of the AUDIO OUTPUT stage through the external or internal receive speaker. In HAIL position, this switch disables the MIC string and feeds 9V from the TX BUS to the anode of diodes D22 and D23 which forward biases them so that they pass the MIC signal to the audio output string Q26, Q25, Q37, Q36, Q34 and Q35. The output of the AUDIO OUTPUT stage Q34 and Q35 is then directed by switch SW304 through a speaker plugged into the HAIL jack.

RECEIVER

4.4 GENERAL

In receive mode, the RF signal is fed from the antenna to the RF AMP Q23. The amplified RF signal is then fed to Q24—the 1st MIXER—where it is mixed with an injection signal 16.9 MHz below the receive channel frequency. Crystal filter FL-1 selects the 16.9 1st IF which is then fed to the 2nd MIXER Q32 together with the 17.355 MHz injection signal. Filter FL-2 selects the resultant 455 kHz 2nd IF. The 455 kHz IF is amplified by Q30, Q31 and fed to slope detector DSC1. The detector audio output is fed to noise amplifiers Q29, Q28 and detector D14, D15 and through squelch switch Q27. The audio, when not squelched, is then fed to 1st, 2nd and 3rd audio amplifiers Q26, Q25 and Q37 respectively. DRIVER—Q36—feeds the audio to OUTPUT amplifier Q34 and Q35 which feeds speaker SP301.

Outputs for each of the 7-segments appear on the PLL chip, Q406 and drive the 7400 nand gates which in turn drive the segments of the displays. Since both displays are driven by the same outputs, the displays are time-share multiplexed. When the segment signals for the left display are presented at the outputs, pin 10 of Q406 goes low causing the emitter of Q507 to enable the common anode of the left display. Likewise, pin 9 of Q406 goes low causing the emitter of Q507 to enable the common anode of the left display.

7-SEGMENT DISPLAYS

Each of the 7-segments of the displays is an LED. Pins 3, 9 and 14 are the common anode while each of the cathodes of each segment appears as a separate input pin on the display chip.

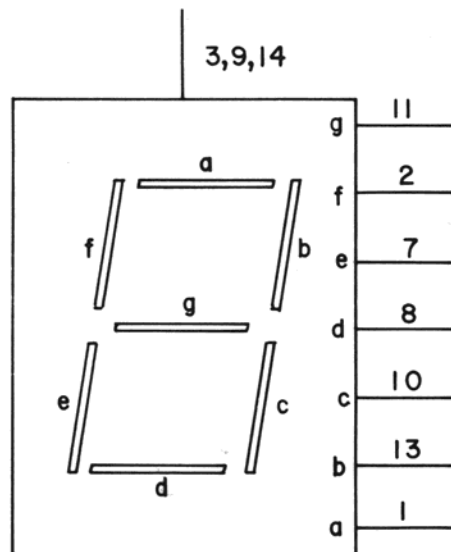

SECTION V
PERFORMANCE VERIFICATION PROCEDURE

1. Pre-select switch positions.
 - A. 1st and 3rd toggle switches "UP" and 2nd or middle "DOWN".
 - B. Volume clockwise to just on.
 - C. Dimmer maximum clockwise.
 - D. Squelch maximum counterclockwise.
2. Connect 50Ω dummy load thru power meter to units antenna connector.
3. Connect red wire from radio to positive side of 13.8 volts DC power supply. Connect black wire from radio to negative side of power supply. Check for:
 - A. Keyboard lights on.
 - B. Receive light on.
 - C. Channel indicator "0 0" flashing display.
 - D. Meter light on.
 - E. Meter indicates approximately 13.8 volts.
4. Check dimmer control and leave in maximum clockwise position.
5. Place "BAT. CK."—"RF Sig" switch in "RF SIG" position.
6. Keyboard push "8 8", "ENTER"—Check LED readout for uniform all segments lit.
7. Key transmitter
 - A. Output should be 25W.
 - B. RFO indication should be in "red" area of meter.
 - C. Frequency should be 157.425 MHz ± 750 Hz.
 - D. Speak into microphone—Deviation should be ± 5 KHz max.
 - E. All spurious greater than 57db down.
8. Place "25W"—"1W" switch in "1W" position.
 - A. Output should be 1W.
 - B. RFO indication should be in "green" area of meter.
 - C. All spurious greater than 43db down.
9. Return switch to "25W" position.
10. Check transmit light, then release key.
11. Keyboard enter channel 24 and key transmitter. Frequency should be 157.200 MHz ± 750 Hz. Release key. Check RFO, Deviation, and spurious as in step 7.
12. Keyboard enter channel 65 and key transmitter.
 - A. Output should be 25W. Frequency should be 156.275 MHz ± 750 Hz.
 - B. Check RFO, Deviation, and spurious as in step 7.
13. Keyboard enter "03" and key transmitter. Should not transmit.
14. Re-enter channel 65.

15. Disconnect dummy load and microphone. Connect signal generator.
16. Inject 156.275 MHz, 1 KHz modulation, 3.5 KHz deviation, @ 0.35 μ v level.
17. Check receive audio. (volume)
18. Rotate squelch to maximum clockwise.
19. Increase generator to 1 μ v, squelch should not break and "S" meter should show slight indication.
20. Increase generator to 100 μ v, squelch should break and "S" meter should be full scale.
21. Reduce generator to 0.35 μ v. Squelch cut off should be sharp. (no long tail) Then rotate squelch to maximum counterclockwise.
22. Connect 3.2 Ω audio dummy load to ext. spkr. jack.
23. Measure receiver sensitivity.
 - A. Should be greater than 12db SINAD @ 0.35 μ v.
 - B. Receive frequency must be within \pm 750 Hz.
24. Increase generator to 100 μ v.
 - A. Audio output should be greater than 4.5W @ 10% distortion.
25. Keyboard enter "0 1".
26. Inject 162.550 MHz, 1 KHz modulation, 3.5 KHz deviation, @ 0.35 μ v level.
27. Repeat step 23.
28. Turn down volume.
29. Disconnect 3.2 Ω audio load from ext. spkr. jack and connect to Hail jack.
30. Place "RADIO"—"HAIL" switch to HAIL position.
31. Key and speak into microphone. Check for 4.5W audio output. Release Key.

SECTION VI

6.1 TROUBLE SHOOTING WITH TRUTH TABLES

Truth tables are essential in trouble shooting logic errors. Table 6-1 shows logic levels (H or L) at various points in the circuit according to channels and ROM outputs. All highs (H) should be greater than 2.0 volts while all lows (L) should be less than 0.8 volts. The high, low or pulse states are best determined with a logic probe. The Hewlett Packard HP 1052T logic probe is recommended. This probe is bright and can be seen at any angle. An oscilloscope can be used to determine high or low levels. When a logic error is found, check back through the logic network until a stage is found which violates a logic rule. Replace defective ICs and check the discrete components of any defective discrete diode-transistor gates. For example, assume that a Key/Com Fifty-Five will operate in receive only and simplex mode, but not in duplex. Check Table and observe that duplex operation occurs only when the Q408 collector is high. If it does go high for duplex channels, check the 12.3 MHz oscillator. If it remains low, check voltage levels on Q408 and diodes D406 and D407. If these levels are correct, check the ROM outputs as shown on the same table. Follow the logic path checking each gate.

Before removing an IC, try to make certain that it is the trouble. When a doubt exists whether an output on one IC or an input on another IC is at fault, a logic pulser should be used to pulse the output-input to the other logic state. A logic probe can then be used to determine if the next stage will respond. To remove an IC, use a low wattage soldering iron and solder wick. Make certain that all of the IC's pins are free before attempting to remove the IC from the board.

TABLE 6-1 PLL TRUTH TABLE

ROM OUTPUTS			D/I INPUT	CHANNELS	Tx OSCILLATORS		MODE
21 A	20 B	19 C	25	Domestic	Q404 P11 SIM 16.9MHz A(C+D)	Q408C DUP 12.3MHz B+CD	
L	L	L	H	01, 02, 03, 04, 05, (30-56), 60, 61, 62, 63, 64, 82	L	L	Receive only
H	L	L	H	07, 18, 19, 21, 22, 23, 65, 66, 78, 79, 80, 81, 83, 88	H	L	Simplex
H	L	H	H	06, 08, 09, 10, 11, 12, 13, 14, 16, 17, 67, 68, 69, 70, 71, 72, 73, 74, 77	H	L	Simplex
L	H	L	H	20, 24, 25, 26, 27, 28, 84, 85, 86, 87	L	H	Duplex
L	L	H	H	15	L	L	Receive only
L	L	L	H	29, 75, 76, (89-99) *	L	L	
				International			
L	L	L	L	01, 02, 03, 04, 05, 60, 61, 62, 63, 64, 82	L	H	Duplex
H	L	L	L	07, 18, 19, 21, 22, 23, 65, 66, 78, 79, 80, 81, 83, 88	L	H	Duplex
H	L	H	L	06, 08, 09, 10, 11, 12, 13, 14, 16, 17, 67, 68, 69, 70, 71, 72, 73, 74, 77	H	L	Simplex
L	H	L	L	20, 24, 25, 26, 27, 28, 84, 85, 86, 87	L	H	Duplex
L	L	H	L	15	L	L	Receive only
L	L	L	L	(29-59), (89-99) *	L	H	

* Illegal channels Tx and Rx are disabled. LOCK (pin 24) goes low

TABLE 6-2 VCO FREQUENCY TABLE

CHANNEL	FRX	FTX	(FRX - 16.9)	VCO= (FRX - 16.9) 5
01	162.55	R.O.	145.65	29.13
02	162.40	R.O.	145.50	29.10
03	162.475	R.O.	145.575	29.115
04	161.650	R.O.	144.750	28.950
05	160.85	R.O.	143.95	28.79
06	156.30	156.30	139.40	27.88
07	156.35	156.35	139.45	27.89
08	156.40	156.40	139.50	27.90
09	156.45	156.45	139.55	27.91
10	156.50	156.50	139.60	27.92
11	156.55	156.55	139.65	27.93
12	156.60	156.60	139.70	27.94
13	156.65	156.65	139.75	27.95
14	156.70	156.70	139.80	27.96
15	156.75	R.O.	139.85	27.97
16	156.80	156.80	139.90	27.98
17	156.85	156.85	139.95	27.99
18	156.90	156.90	140.00	28.00
19	156.95	156.95	140.05	28.01
20	161.60	157.00	144.70	28.94
21	157.05	157.05	140.15	28.03
22	157.10	157.10	140.20	28.04
23	157.15	157.15	140.25	28.05
24	161.80	157.20	144.90	28.98
25	161.85	157.25	144.95	28.99
26	161.90	157.30	145.00	29.00
27	161.95	157.35	145.05	29.01
28	162.00	157.40	145.10	29.02
29	ILL. Ch.			
30	153.95	R.O.	137.05	27.41
31	154.175	R.O.	137.275	27.455
32	154.25	R.O.	137.35	27.47
33	154.40	R.O.	137.50	27.50
34	154.65	R.O.	137.75	27.55
35	154.725	R.O.	137.825	27.565
36	154.80	R.O.	137.90	27.58
37	154.875	R.O.	137.975	27.595
38	154.950	R.O.	138.05	27.610
39	155.25	R.O.	138.35	27.67
40	155.325	R.O.	138.425	27.685
41	155.40	R.O.	138.50	27.70
42	155.475	R.O.	138.575	27.715
43	155.55	R.O.	138.65	27.73
44	155.625	R.O.	138.725	27.745
45	155.70	R.O.	138.80	27.76
46	155.85	R.O.	138.95	27.79
47	156.15	R.O.	139.25	27.85
48	158.85	R.O.	141.94	28.39
49	159.15	R.O.	142.25	28.45
50	155.025	R.O.	138.125	27.625
51	155.775	R.O.	138.875	27.775
52	155.925	R.O.	139.025	27.805
53	156.000	R.O.	139.100	27.820
54	156.225	R.O.	139.325	27.865
55	154.025	R.O.	137.125	27.425
56	154.100	R.O.	137.200	27.440
57	ILL. Ch.			

CHANNEL	FRX	FTX	(FRX - 16.9)	$\frac{VCO}{5} = (FRX - 16.9)$
58	ILL. Ch.			
59	ILL. Ch.			
60	160.625	R.O.	143.725	28.745
61	160.675	R.O.	143.775	28.755
62	160.725	R.O.	143.825	28.765
63	160.775	R.O.	143.875	28.775
64	160.825	R.O.	143.925	28.785
65	156.275	156.275	139.375	27.875
66	156.325	156.325	139.425	27.885
67	156.375	156.375	139.475	27.895
68	156.425	156.425	139.525	27.905
69	156.475	156.475	139.575	27.915
70	156.525	156.525	139.625	27.925
71	156.575	156.575	139.675	27.935
72	156.625	156.625	139.725	27.945
73	156.675	156.675	139.775	27.995
74	156.725	156.725	139.825	27.965
75	ILL. Ch.			
76	ILL. Ch.			
77	156.875	156.875	139.975	27.995
78	156.925	156.925	140.025	28.005
79	156.975	156.975	140.075	28.015
80	157.025	157.025	140.125	28.025
81	157.075	157.075	140.175	28.035
82	161.725	R.O.	144.825	28.965
83	157.175	157.175	140.275	28.055
84	161.825	157.225	144.925	28.985
85	161.875	157.275	144.975	28.995
86	161.925	157.325	145.025	29.005
87	161.975	157.375	145.075	29.015
88	157.425	157.425	140.525	28.105

DIGITAL SYNTHESIZER FREQUENCY SCHEME

REFERENCE OSCILLATOR Q411 = 10.24 MHz

REFERENCE FREQUENCY Q406 pin 22

$$F_{ref} = \frac{REF_OSC}{4} = \frac{10.24\text{ MHz}}{4} = 2.56\text{ MHz}$$

$$VCO = \frac{FRX - 16.9}{5}$$

TX: $F_{TX} = 5 \cdot (VCO) + 16.9$ (Simplex)

$F_{TX} = 5 \cdot (VCO) + 12.3$ (Duplex)

RX: 1st L.O. = $5 \cdot (VCO) = FRX - 16.9$

2nd L.O. = 17.355 MHz

$17.355\text{ MHz} - (FRX - 1st\ LO) = 455\text{ KHz IF}$

SERVICE

To avoid switching large currents through inductive loads which may cause arcing and subsequent corrosion of switch contacts in a marine environment, SBE has designed the transmitter section to be electronically switched. Not **all** voltages are thus switched off by the power switch.

WARNING: DISCONNECT THE POWER SUPPLY WITH THE POWER SWITCH ON BEFORE MAKING ANY REPAIRS.

TABLE 6-3 PLL TROUBLESHOOTING CHART

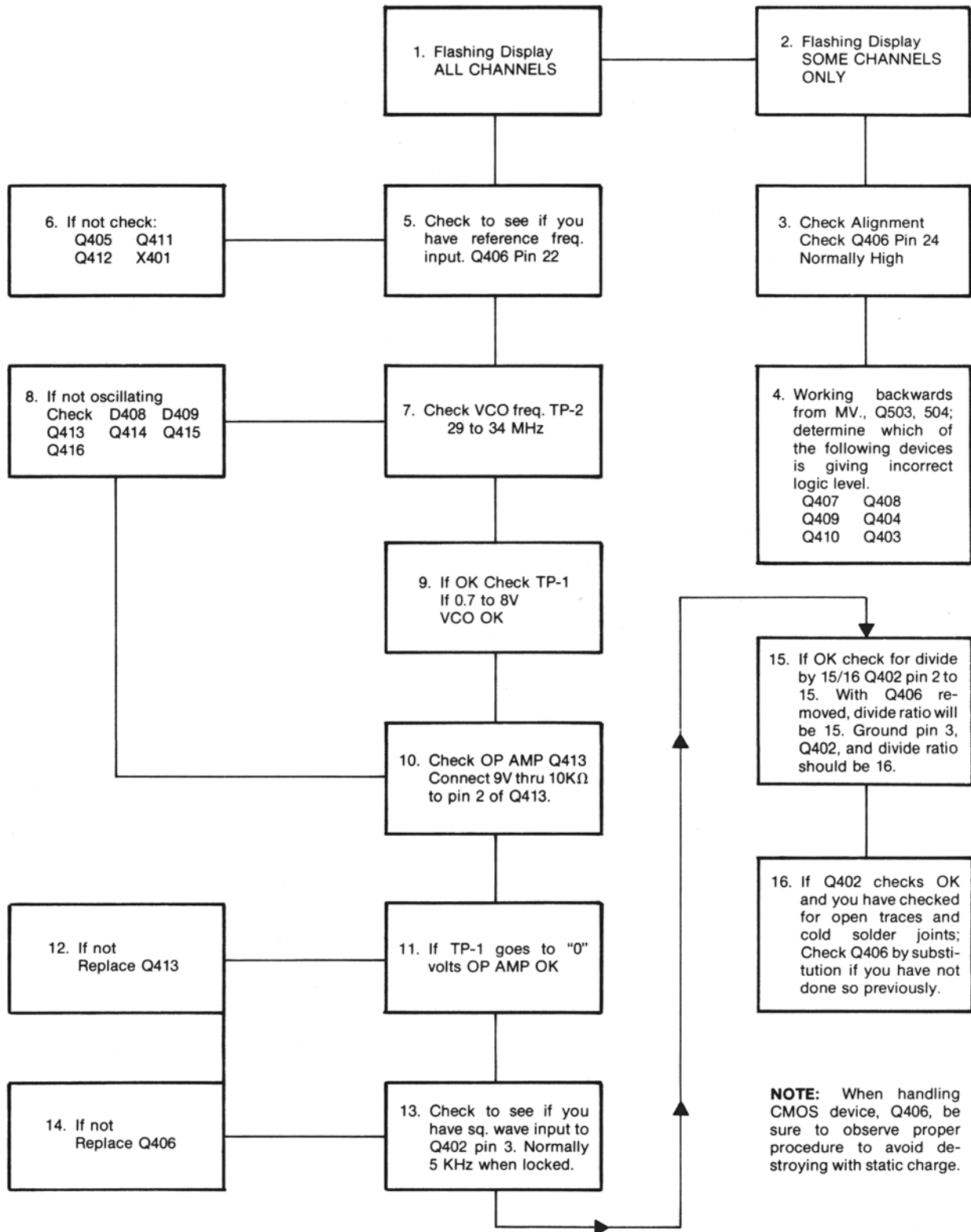

FIG. 6-1 PLL BLOCK DIAGRAM

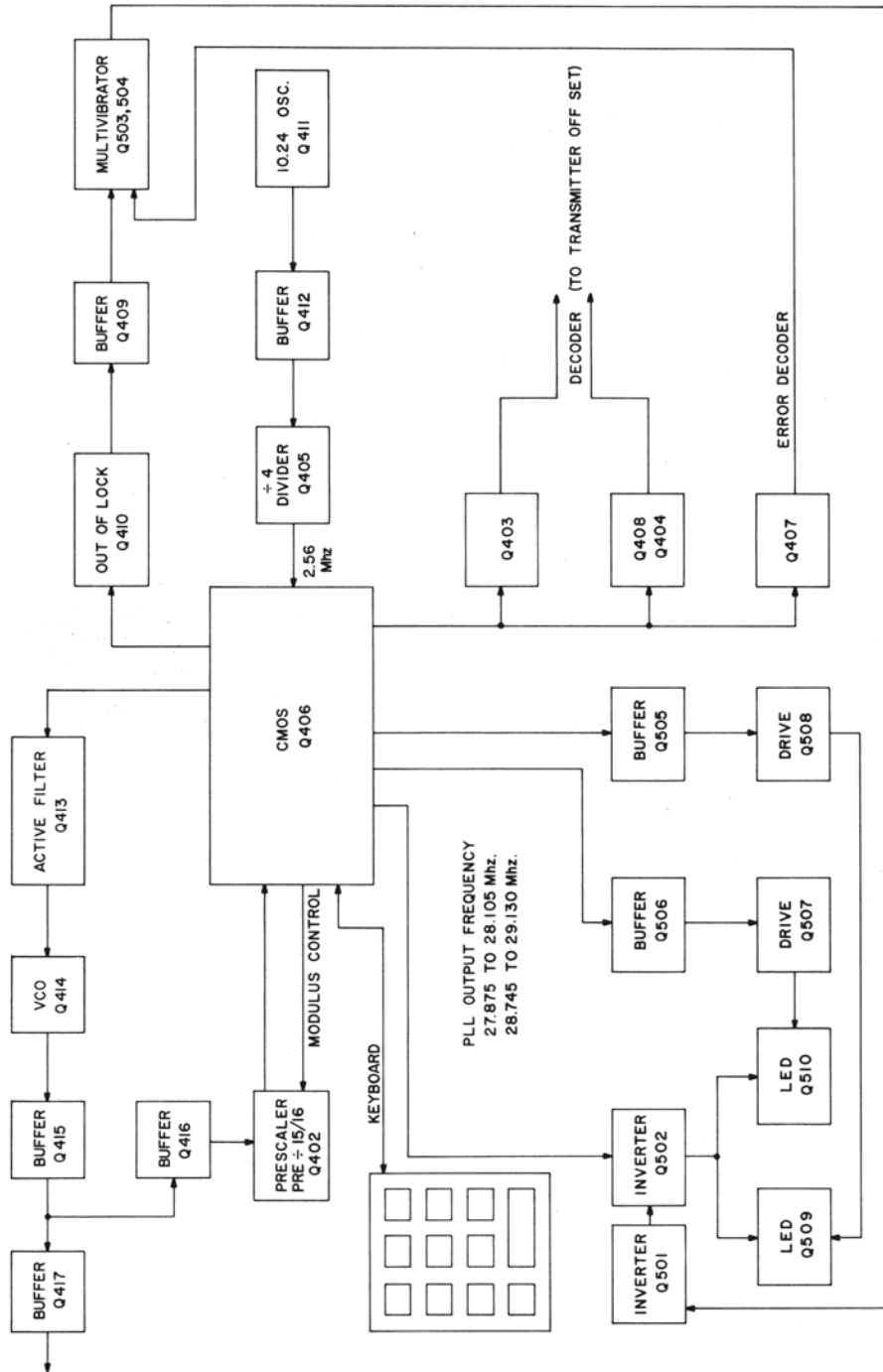

FIG. 6-2 BLOCK DIAGRAM RF SECTION

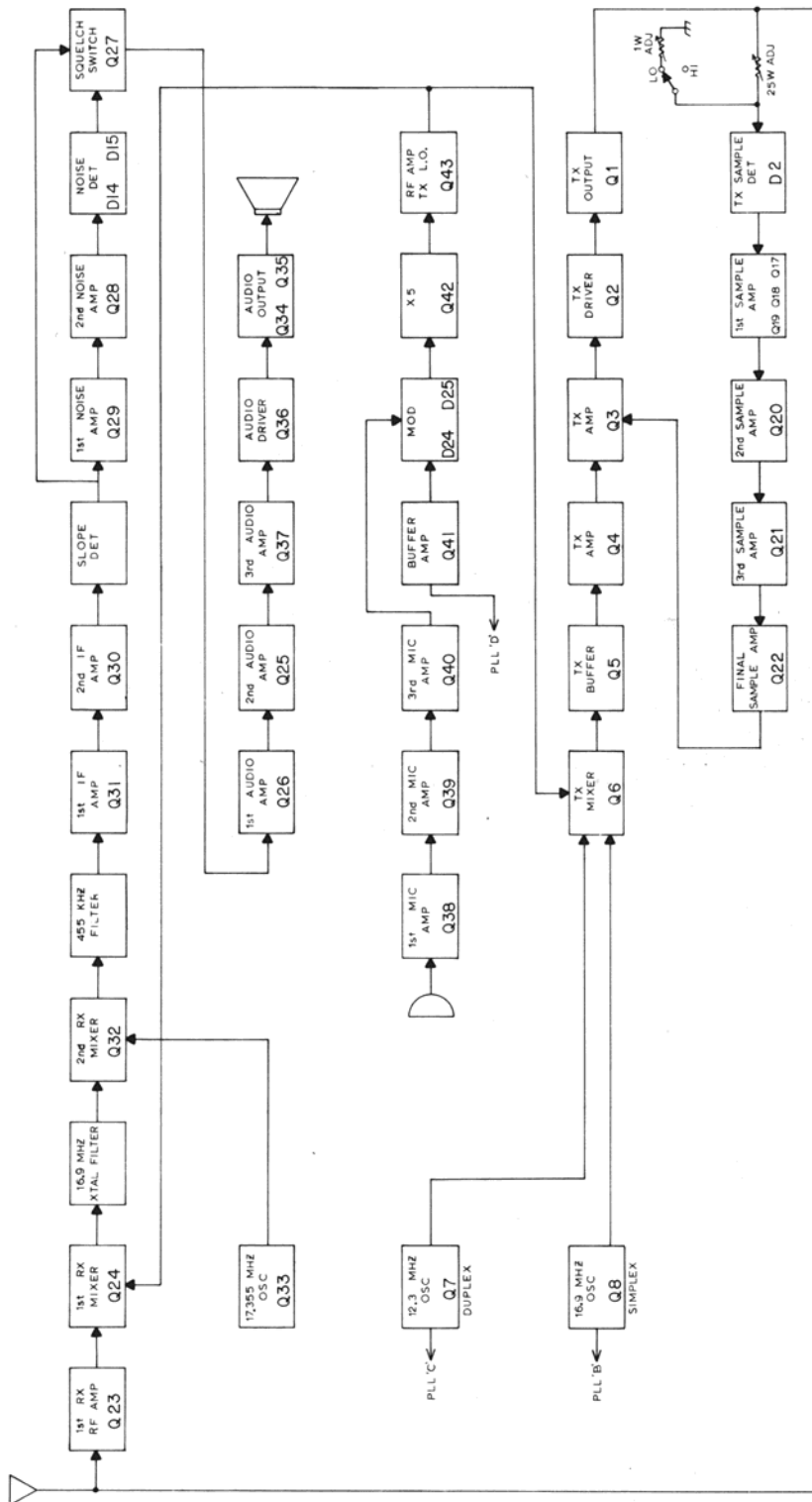

FIG. 6-3 CHASSIS WIRING DIAGRAM

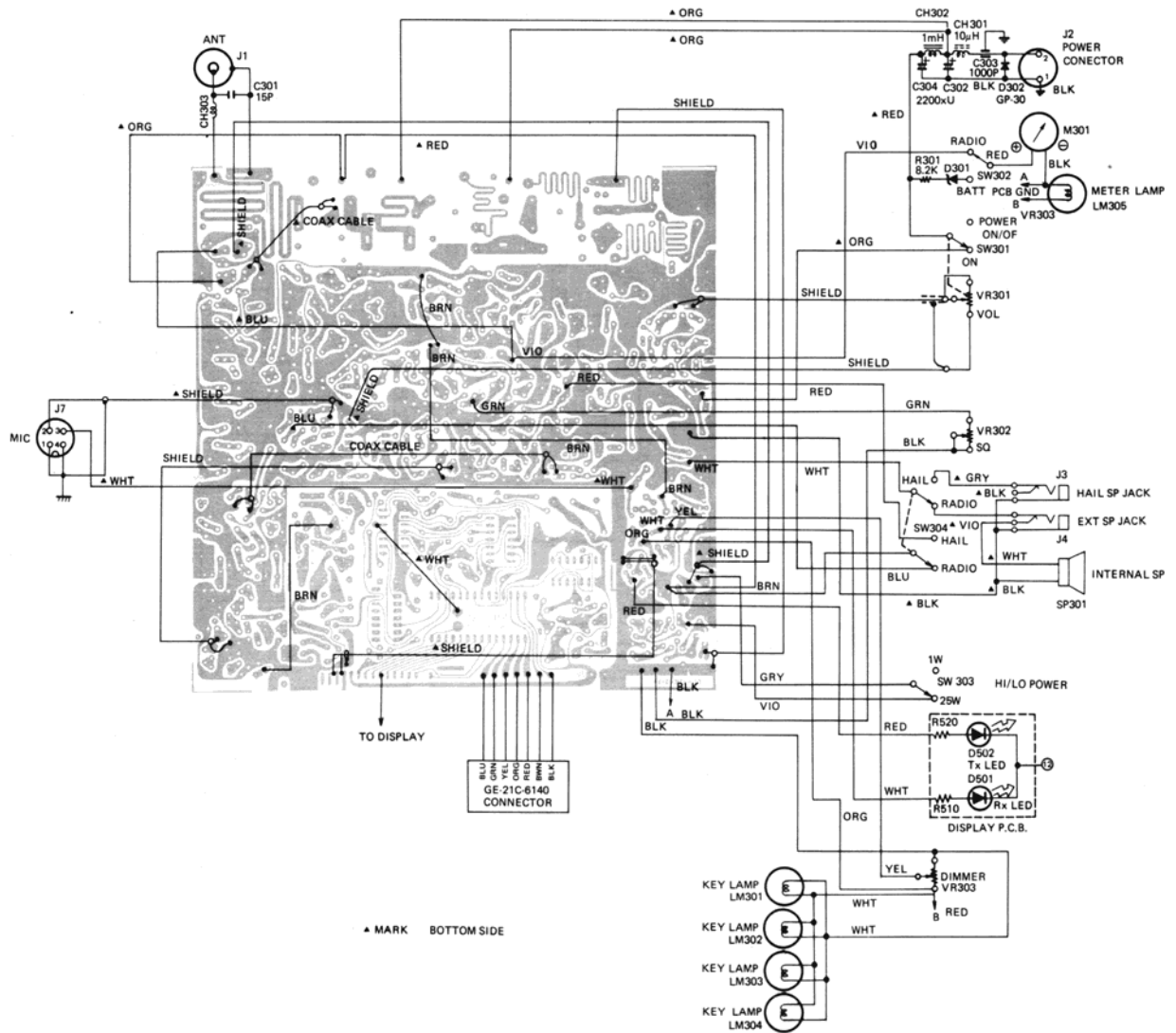
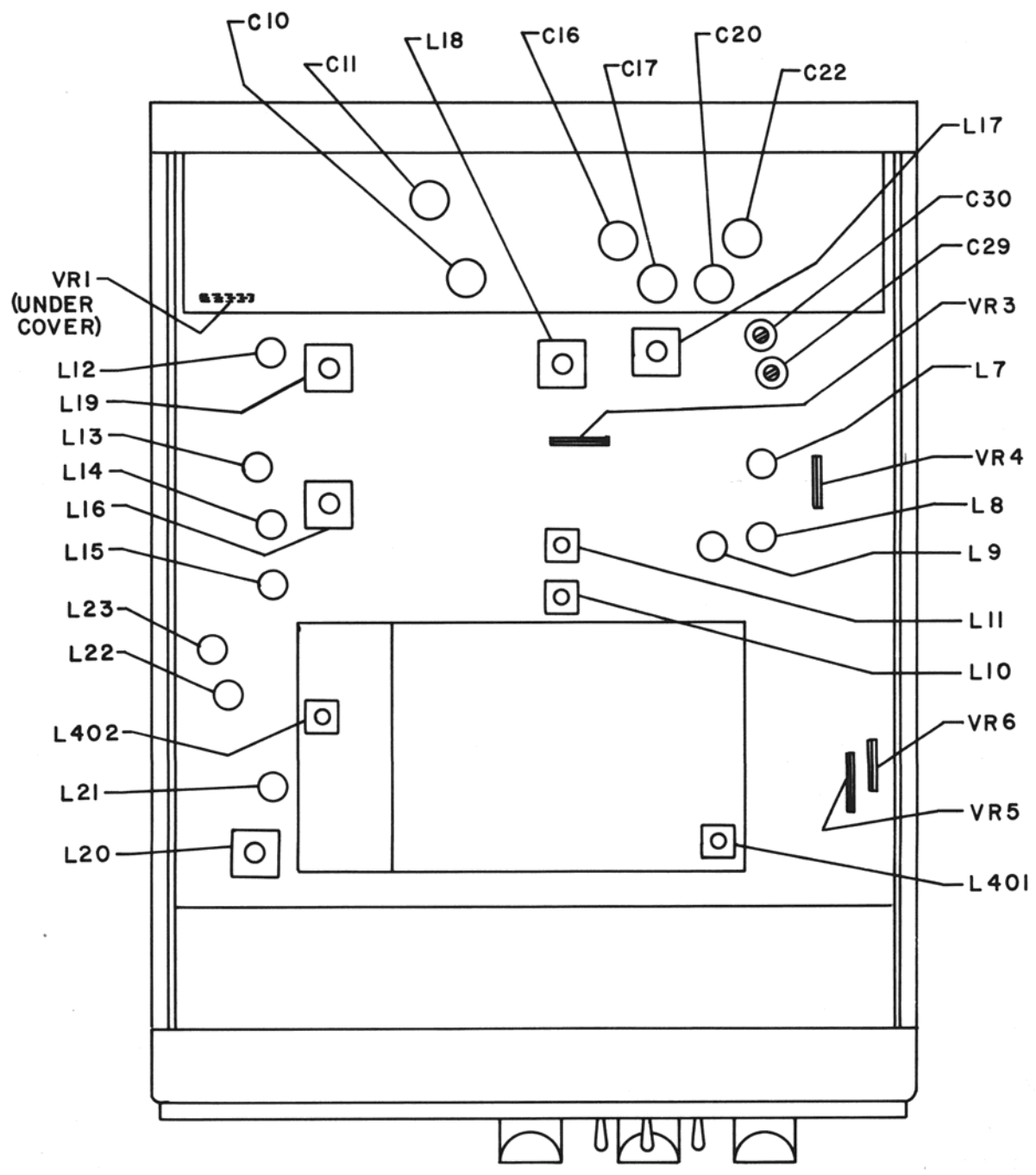

FIG. 6-4 ALIGNMENT LAYOUT



PLL ALIGNMENT

INITIAL SET-UP

Connect oscilloscope to TP1 and frequency counter to TP2. Set to channel 20. Check that 20 is displayed. Disregard flashing display at this time.

STEP 1

Adjust L402 for 6V DC \pm 0.2V @ TP-1

Note: If L402 will not adjust, refer to PLL troubleshooting procedure.

STEP 2

Adjust L401 for 28.94 MHz @ TP-2

STEP 3

Enter channel 01, 88, and 65. If any of these have a flashing display, alternately adjust L402 (not to exceed 6.2V) and L401 as follows:

CHANNEL	FREQUENCY
01	29.13
88	28.11
65	27.88

STEP 4

Check to see that channels 01, 20, 65 and 88, when entered, are displayed but are not flashing.

x5 MULTIPLIER STAGE ALIGNMENT

STEP 1

Set to Channel 20. Connect DC voltmeter to TP 3. Adjust L20 for maximum meter indication.

STEP 2

Set to Channel 16. Connect DC voltmeter to TP4. Alternately adjust L21, L22 for maximum meter indication.

X5 MULTIPLIER STAGE ALIGNMENT, cont.

STEP 3

Set to Channel 20. Adjust L23 for maximum meter indication.

STEP 4

Set to Channel 16. Adjust L22 for maximum meter indication.

STEP 5

Repeat steps 3 and 4 as necessary.

Note: Optimum adjustment will be obtained when there is minimum shift in DC voltage while switching between channels 16 and 20.

RECEIVER ALIGNMENT

INITIAL SET-UP

Connect the frequency counter to TP5, the distortion meter and oscilloscope to the EXT SP jack, the signal generator to the antenna connector.

STEP 1

Check frequency counter. Frequency should be $17.355 \text{ MHz} \pm 300 \text{ Hz}$.

STEP 2

Set signal generator for 156.800 MHz signal, 300 mV STD modulation. Adjust L16 and L19 alternately for maximum SINAD. Adjust L18 for maximum S-MTR, and L17 for maximum audio on scope.

STEP 3

Reduce generator output as necessary. Alternately adjust L12, 13, 14, 15 for best SINAD. Set generator to channel 26 (161.90) and adjust L14 for best SINAD.

STEP 4

Set generator back to channel 16 (156.80 MHz) @ $100 \mu\text{v}$. Adjust VR4 for equal clipping at maximum audio. ($\approx 6\text{V P-P}$ @ $\leq 10\%$ distortion).

TRANSMITTER ALIGNMENT

INITIAL SET-UP

Connect the frequency counter to TP7, and a 50 Ω load and wattmeter to the antenna connector.

STEP 1

Set to channel 20. Key MIC and adjust L10 for 12.3 MHz \pm 20.0 Hz.

STEP 2

Set to channel 18. Key MIC and adjust L11 for 16.9 MHz \pm 20.0 Hz.

STEP 3

25W/1W power switch to 1W position. Connect low side of DC voltmeter to TP9 and high side to TP8. Alternately adjust L7, 8, 9 for maximum meter indication.

STEP 4

Connect low side DC voltmeter to ground and the high side to TP10. Alternately adjust C30 and C29 for maximum indication.

STEP 5

Set 25W/1W power switch on front panel to 25W position and adjust VR6 to end of travel that gives maximum power. Alternately adjust C21, 22, 17, 16, 11 and 10 for maximum power.

STEP 6

Set 25W/1W switch to 1W and adjust VR5 for 1W TX out.

STEP 7

Set 25W/1W to 25W again and adjust VR6 for 25W TX out. Adjust VR1 for 75% red scale on RFO meter.

STEP 8

Set to channel 20. Check 25W/1W switch on power meter and RFO meter.

STEP 9

Set 25W/1W switch to 25W. Select frequency channel 65. Whistle loudly into the MIC or feed in 1 kHz tone from generator. Adjust VR2 for 5 kHz maximum deviation.

**SECTION VII
SBE KEY/COM 55 PARTS LIST**

SYMBOL #	PART #	DESCRIPTION
C1	8000-00040-048	Capacitor, 33 pfd, 50V, Ceramic
C2	8000-00040-048	Capacitor, 33 pfd, 50V, Ceramic
C3	8000-00048-027	Capacitor, 3 pfd, 50V, Ceramic
C4	8000-00006-076	Capacitor, 0.005 mfd, 50V, Ceramic
C5	8000-00048-028	Capacitor, 15 pfd, 50V, Ceramic
C7	8000-00048-029	Capacitor, BLT1H472NA
C8	8000-00048-030	Capacitor, Feed Through
C9	8000-00048-030	Capacitor, Feed Through
C10	8000-00048-031	Capacitor, CV01C 450, Trimmer
C11	8000-00048-031	Capacitor, CV01C 450, Trimmer
C12	8000-00040-054	Capacitor, 10 mfd, 35V, Elect.
C13	8000-00048-030	Capacitor, Feed Through
C14	8000-00006-076	Capacitor, 0.005 mfd, 50V, Ceramic
C15	8000-00006-076	Capacitor, 0.005 mfd, 50V, Ceramic
C16	8000-00048-031	Capacitor, CV01C 450, Trimmer
C17	8000-00028-156	Capacitor, 20 pfd, Trimmer
C18	8000-00040-054	Capacitor, 10 mfd, 35V, Elect.
C19	8000-00048-030	Capacitor, Feed Through
C20	8000-00048-028	Capacitor, 15 pfd, 50V, Ceramic
C21	8000-00028-156	Capacitor, 20 pfd, Trimmer
C22	8000-00028-156	Capacitor, 20 pfd, Trimmer
C23	8000-00028-026	Capacitor, 10 mfd, 16V, Elect.
C24	8000-00028-013	Capacitor, 0.001 mfd, 50V, Ceramic
C25	8000-00006-076	Capacitor, 0.005 mfd, 50V, Ceramic
C26	8000-00048-032	Capacitor, 33 pfd, 50V, N330, Ceramic
C27	8000-00048-032	Capacitor, 33 pfd, 50V, N330, Ceramic
C28	8000-00028-002	Capacitor, 0.5 pfd, 50V, Ceramic
C29	8000-00048-033	Capacitor, 6 pfd, Trimmer
C30	8000-00048-033	Capacitor, 6 pfd, Trimmer
C31	8000-00028-013	Capacitor, 0.001 mfd, 50V, Ceramic
C32	8000-00028-013	Capacitor, 0.001 mfd, 50V, Ceramic
C33	8000-00006-076	Capacitor, 0.005 mfd, 50V, Ceramic
C34	8000-00048-028	Capacitor, 15 pfd, 50V, Ceramic
C35	8000-00048-034	Capacitor, 5 pfd, 50V, Ceramic
C36	8000-00006-076	Capacitor, 0.005 mfd, 50V, Ceramic
C37	8000-00028-026	Capacitor, 10 mfd, 16V, Elect.
C38	8000-00048-028	Capacitor, 15 pfd, 50V, Ceramic
C39	8000-00040-047	Capacitor, 4 pfd, 50V, Ceramic
C40	8000-00028-002	Capacitor, 0.5 pfd, 50V, Ceramic
C41	8000-00028-002	Capacitor, 0.5 pfd, 50V, Ceramic
C42	8000-00048-035	Capacitor, 3 pfd, 50V, Ceramic
C43	8000-00006-076	Capacitor, 0.005 mfd, 50V, Ceramic
C44	8000-00028-013	Capacitor, 0.001 mfd, 50V, Ceramic
C45	8000-00048-036	Capacitor, 47 pfd, 50V, N330, Ceramic
C46	8000-00048-037	Capacitor, 150 pfd, 50V, N750, Ceramic
C47	8000-00048-038	Capacitor, 82 pfd, 50V, N750, Ceramic
C48	8000-00048-039	Capacitor, 24 pfd, 50V, N150, Ceramic
C49	8000-00028-013	Capacitor, 0.001 mfd, 50V, Ceramic
C50	8000-00048-032	Capacitor, 33 pfd, 50V, N330, Ceramic
C51	8000-00048-038	Capacitor, 82 pfd, 50V, N750, Ceramic

SYMBOL #	PART #	DESCRIPTION
C52	8000-00048-038	Capacitor, 82 pfd, 50V, N750, Ceramic
C53	8000-00028-013	Capacitor, 0.001 mfd, 50V, Ceramic
C54	8000-00048-039	Capacitor, 24 pfd, 50V, N150, Ceramic
C55	8000-00006-076	Capacitor, 0.005 mfd, 50V, Ceramic
C56	8000-00028-023	Capacitor, 47 mfd, 16V, Elect.
C57	8000-00006-076	Capacitor, 0.005 mfd, 50V, Ceramic
C58	8000-00006-076	Capacitor, 0.005 mfd, 50V, Ceramic
C59	8000-00028-026	Capacitor, 10 mfd, 16V, Elect.
C60	8000-00048-040	Capacitor, 2.2 mfd, 16V, Tant.
C61	8000-00006-076	Capacitor, 0.005 mfd, 50V, Ceramic
C62	8000-00028-013	Capacitor, 0.001 mfd, 50V, Ceramic
C63	8000-00028-013	Capacitor, 0.001 mfd, 50V, Ceramic
C64	8000-00048-034	Capacitor, 5 pfd, 50V, Ceramic
C65	8000-00028-192	Capacitor, 2 pfd, 50V, Ceramic
C66	8000-00028-013	Capacitor, 0.001 mfd, 50V, Ceramic
C67	8000-00006-076	Capacitor, 0.005 mfd, 50V, Ceramic
C68	8000-00006-076	Capacitor, 0.005 mfd, 50V, Ceramic
C69	8000-00048-034	Capacitor, 5 pfd, 50V, Ceramic
C70	8000-00006-076	Capacitor, 0.005 mfd, 50V, Ceramic
C71	8000-00028-013	Capacitor, 0.001 mfd, 50V, Ceramic
C72	8000-00028-013	Capacitor, 0.001 mfd, 50V, Ceramic
C73	8000-00028-013	Capacitor, 0.001 mfd, 50V, Ceramic
C74	8000-00028-194	Capacitor, 7 pfd, 50V, Ceramic
C75	8000-00028-013	Capacitor, 0.001 mfd, 50V, Ceramic
C76	8000-00040-047	Capacitor, 4 pfd, 50V, Ceramic
C77	8000-00028-001	Capacitor, 8 pfd, 50V, Ceramic
C78	8000-00048-028	Capacitor, 15 pfd, 50V, Ceramic
C79	8000-00006-076	Capacitor, 0.005 mfd, 50V, Ceramic
C80	8000-00048-028	Capacitor, 15 pfd, 50V, Ceramic
C81	8000-00006-276	Capacitor, 0.047 mfd, 50V, Mylar
C82	8000-00006-076	Capacitor, 0.005 mfd, 50V, Ceramic
C83	8000-00006-076	Capacitor, 0.005 mfd, 50V, Ceramic
C84	8000-00028-026	Capacitor, 10 mfd, 16V, Elect.
C85	8000-00048-040	Capacitor, 2.2 mfd, 16V, Tant.
C86	8000-00048-041	Capacitor, 0.0022 mfd, 50V, Mylar
C87	8000-00028-005	Capacitor, 0.01 mfd, 50V, Mylar
C88	8000-00048-040	Capacitor, 2.2 mfd, 16V, Tant.
C89	8000-00048-042	Capacitor, 1mfd, 16V, Tant.
C90	8000-00048-042	Capacitor, 1 mfd, 16V, Tant.
C91	8000-00048-040	Capacitor, 2.2 mfd, 16V, Tant.
C92	8000-00024-207	Capacitor, 0.0033 mfd, 50V, Mylar
C93	8000-00048-040	Capacitor, 2.2 mfd, 16V, Tant.
C94	8000-00048-040	Capacitor, 2.2 mfd, 16V, Tant.
C95	8000-00048-040	Capacitor, 2.2 mfd, 16V, Tant.
C96	8000-00048-043	Capacitor, 0.0047 mfd, 50V, Mylar
C97	8000-00041-009	Capacitor, 0.033 mfd, 50V, Mylar
C98	8000-00048-041	Capacitor, 0.0022 mfd, 50V, Mylar
C99	8000-00024-207	Capacitor, 0.0022 mfd, 50V, Mylar
C100	8000-00048-041	Capacitor, 0.0022 mfd, 50V, Mylar
C101	8000-00028-005	Capacitor, 0.01 mfd, 50V, Ceramic
C102	8000-00048-040	Capacitor, 2.2 mfd, 16V, Tant.
C103	8000-00048-040	Capacitor, 2.2 mfd, 16V, Tant.
C104	8000-00006-276	Capacitor, 0.047 mfd, 50V, Mylar

SYMBOL #	PART #	DESCRIPTION
C105	8000-00006-276	Capacitor, 0.047 mfd, 50V, Mylar
C106	8000-00006-276	Capacitor, 0.047 mfd, 50V, Mylar
C107	8000-00006-076	Capacitor, 0.005 mfd, 50V, Ceramic
C108	8000-00006-076	Capacitor, 0.005 mfd, 50V, Ceramic
C109	8000-00006-076	Capacitor, 0.005 mfd, 50V, Ceramic
C110	8000-00006-276	Capacitor, 0.047 mfd, 50V, Mylar
C111	8000-00006-276	Capacitor, 0.047 mfd, 50V, Mylar
C112	8000-00006-276	Capacitor, 0.047 mfd, 50V, Mylar
C113	8000-00006-276	Capacitor, 0.047 mfd, 50V, Mylar
C114	8000-00006-276	Capacitor, 0.047 mfd, 50V, Mylar
C115	8000-00006-276	Capacitor, 0.047 mfd, 50V, Mylar
C116	8000-00048-046	Capacitor, 24 pfd, 50V, Ceramic
C117	8000-00028-013	Capacitor, 0.001 mfd, 50V, Ceramic
C118	8000-00048-034	Capacitor, 5 pfd, 50V, Ceramic
C119	8000-00048-037	Capacitor, 150 pfd, 50V, N750, Ceramic
C120	8000-00048-044	Capacitor, 220 pfd, 50V, N750, Ceramic
C121	8000-00006-276	Capacitor, 0.047 mfd, 50V, Mylar
C122	8000-00040-041	Capacitor, 20 pfd, 50V, Ceramic
C123	8000-00028-023	Capacitor, 47 mfd, 16V, Elect.
C124	8000-00006-076	Capacitor, 0.005 mfd, 50V, Ceramic
C125	8000-00011-143	Capacitor, 470 mfd, 16V, Elect.
C126	8000-00011-143	Capacitor, 470 mfd, 16V, Elect.
C127	8000-00028-023	Capacitor, 47 mfd, 16V, Elect.
C128	8000-00028-013	Capacitor, 0.001 mfd, 50V, Ceramic
C129	8000-00028-013	Capacitor, 0.001 mfd, 50V, Ceramic
C130	8000-00006-276	Capacitor, 0.047 mfd, 50V, Mylar
C131	8000-00048-040	Capacitor, 2.2 mfd, 16V, Tant.
C132	8000-00048-045	Capacitor, 33 mfd, 6.3V, Tant.
C133	8000-00048-040	Capacitor, 2.2 mfd, 16V, Tant.
C134	8000-00048-040	Capacitor, 2.2 mfd, 16V, Tant.
C135	8000-00048-040	Capacitor, 2.2 mfd, 16V, Tant.
C136	8000-00041-009	Capacitor, 0.033 mfd, 50V, Mylar
C137	8000-00048-040	Capacitor, 2.2 mfd, 16V, Tant.
C138	8000-00048-047	Capacitor, 100 pfd, 50V, N750, Ceramic
C139	8000-00048-047	Capacitor, 100 pfd, 50V, N750, Ceramic
C140	8000-00048-040	Capacitor, 2.2 mfd, 16V, Tant.
C141	8000-00028-026	Capacitor, 10 mfd, 16V, Elect.
C142	8000-00048-048	Capacitor, 47 mfd, 6.3V, Tant.
C143	8000-00048-040	Capacitor, 2.2 mfd, 16V, Tant.
C144	8000-00024-207	Capacitor, 0.0033 mfd, 50V, Mylar
C145	8000-00028-005	Capacitor, 0.01 mfd, 50V, Mylar
C146	8000-00028-026	Capacitor, 10 mfd, 16V, Elect.
C147	8000-00006-276	Capacitor, 0.047 mfd, 50V, Mylar
C148	8000-00048-040	Capacitor, 2.2 mfd, 16V, Tant.
C149	8000-00028-197	Capacitor, 470 pfd, 50V, Ceramic
C150	8000-00028-026	Capacitor, 10 mfd, 16V, Elect.
C151	8000-00028-013	Capacitor, 0.001 mfd, 50V, Ceramic
C152	8000-00028-010	Capacitor, 10 pfd, 50V, Ceramic
C153	8000-00006-076	Capacitor, 0.005 mfd, 50V, Ceramic
C154	8000-00028-010	Capacitor, 10 pfd, 50V, Ceramic
C155	8000-00006-076	Capacitor, 0.005 mfd, 50V, Ceramic
C156	8000-00006-076	Capacitor, 0.005 mfd, 50V, Ceramic
C157	8000-00048-035	Capacitor, 3 pfd, 50V, Ceramic

SYMBOL #	PART #	DESCRIPTION
C158	8000-00048-028	Capacitor, 15 pfd, 50V, Ceramic
C159	8000-00040-047	Capacitor, 4 pfd, 50V, Ceramic
C160	8000-00048-035	Capacitor, 3 pfd, 50V, Ceramic
C161	8000-00006-076	Capacitor, 0.005 mfd, 50V, Ceramic
C162	8000-00006-076	Capacitor, 0.005 mfd, 50V, Ceramic
C163	8000-00048-049	Capacitor, 18 pfd, 50V, N220, Ceramic
C164	8000-00048-049	Capacitor, 18 pfd, 50V, N220, Ceramic
C166	8000-00048-029	Capacitor, BLT1H472NA
C167	8000-00048-047	Capacitor, 100 pfd, 50V, N750, Ceramic
C168	8000-00007-076	Capacitor, 0.005 mfd, 50V, Ceramic
C169	8000-00028-002	Capacitor, 0.5 pfd, 50V, Ceramic
C170	8000-00048-028	Capacitor, 15 pfd, 50V, Ceramic
C171	8000-00048-047	Capacitor, 100 pfd, 50V, N750, Ceramic
C301	8000-00048-028	Capacitor, 15 pfd, 50V, Ceramic
C302	8000-00028-033	Capacitor, 2200 mfd, 16V, Elect.
C303	8000-00048-050	Capacitor, Feed Through
C304	8000-00028-033	Capacitor, 2200 mfd, 16V, Elect.
C401	8000-00028-031	Capacitor, 470 mfd, 10V, Elect.
C402	8000-00028-031	Capacitor, 470 mfd, 10V, Elect.
C403	8000-00028-021	Capacitor, 0.1 mfd, 50V, Mylar
C404	8000-00006-076	Capacitor, 0.005 mfd, 50V, Ceramic
C405	8000-00006-076	Capacitor, 0.005 mfd, 50V, Ceramic
C406	8000-00041-009	Capacitor, 0.033 mfd, 50V, Mylar
C407	8000-00040-134	Capacitor, 1 mfd, 25V, Tant.
C408	8000-00048-039	Capacitor, 24 pfd, 50V, N150, Ceramic
C409	8000-00048-037	Capacitor, 150 pfd, 50V, N750, Ceramic
C410	8000-00048-037	Capacitor, 150 pfd, 50V, N750, Ceramic
C411	8000-00028-027	Capacitor, 100 mfd, 16V, Elect.
C412	8000-00006-076	Capacitor, 0.005 mfd, 50V, Ceramic
C413	8000-00028-013	Capacitor, 0.001 mfd, 50V, Ceramic
C414	8000-00006-276	Capacitor, 0.047 mfd, 50V, Mylar
C415	8000-00028-200	Capacitor, 0.022 mfd, 50V, Mylar
C416	8000-00040-134	Capacitor, 1 mfd, 25V, Tant.
C417	8000-00028-034	Capacitor, .1 mfd, 16V, Tant.
C418	8000-00006-076	Capacitor, 0.005 mfd, 50V, Ceramic
C419	8000-00006-076	Capacitor, 0.005 mfd, 50V, Ceramic
C420	8000-00028-200	Capacitor, 0.022 mfd, 50V, Mylar
C421	8000-00048-046	Capacitor, 24 pfd, 50V, Ceramic
C422	8000-00028-001	Capacitor, 8 pfd, 50V, Ceramic
C423	8000-00048-051	Capacitor, 68 pfd, 50V, N470, Ceramic
C424	8000-00048-038	Capacitor, 82 pfd, 50V, N750, Ceramic
C425	8000-00028-027	Capacitor, 100 mfd, 16V, Elect.
C426	8000-00028-001	Capacitor, 8 pfd, 50V, Ceramic
C427	8000-00028-013	Capacitor, 0.001 mfd, 50V, Ceramic
C428	8000-00048-052	Capacitor, 33 pfd, 50V, N150, Ceramic
C429	8000-00028-013	Capacitor, 0.001 mfd, 50V, Ceramic
C430	8000-00028-013	Capacitor, 0.001 mfd, 50V, Ceramic
C508	8000-00028-013	Capacitor, 0.001mfd, 50V, Ceramic
C509	8000-00028-024	Capacitor, .1 mfd, 50V, Elect.
C510	8000-00028-024	Capacitor, .1 mfd, 50V, Elect.

SYMBOL #	PART #	DESCRIPTION
C511	8000-00048-053	Capacitor, 470 mfd, 6.3V, Elect.
C512	8000-00006-076	Capacitor, 0.005 mfd, 50V, Ceramic
CH1	8000-00048-055	Choke, 4LNC-111, 1 μ H
CH2	8000-00048-055	Choke, 4LNC-111, 1 μ H
CH3	8000-00048-055	Choke, 4LNC-111, 1 μ H
CH4	8000-00048-071	Choke, 4LNC-111, 3.9MH
CH5	8000-00011-020	Choke, 4LNC-111, 470 μ H
CH6	8000-00011-020	Choke, 4LNC-111, 2.2 μ H
CH7	8000-00028-143	Choke, 4LNC-111, 2.2 μ H
CH8	8000-00028-143	Choke, 4LNC-111, 1 μ H
CH9	8000-00048-055	Choke, 4LNC-111, 1 μ H
CH301	8000-00048-072	Line Choke, SN12-400
CH302	8000-00048-073	Line Choke, E6807
CH303	8000-00048-054	Air Coil, 8LNC-112
D1	8000-00028-267	Diode, 1S1588 or (HV-80)
D2	8000-00028-267	Diode, 1S1588 or (HV-80)
D3	8000-00048-018	Diode, M1402
D4	8000-00006-201	Diode, S1B01-02
D5	8000-00043-021	Diode, EQA-01-09S
D6	8000-00026-201	Diode, S1B01-02
D7	8000-00028-267	Diode, 1S1588 or (HV-80)
D8	8000-00048-019	Diode, M1301
D9	8000-00048-019	Diode, M1301
D10	8000-00038-010	Diode, MV201 or (T18)
D11	8000-00038-010	Diode, MV201 or (T18)
D12	8000-00038-010	Diode, MV201 or (T18)
D13	8000-00038-010	Diode, MV201 or (T18)
D14	8000-00028-267	Diode, 1S1588 or (HV-80)
D15	8000-00028-267	Diode, 1S1588 or (HV-80)
D16	8000-00006-007	Diode, 1N60
D17	8000-00006-007	Diode, 1N60
D18	8000-00028-267	Diode, 1S1588 or (HV-80)
D19	8000-00028-267	Diode, 1S1588 or (HV-80)
D20	8000-00028-267	Diode, 1S1588 or (HV-80)
D21	8000-00028-267	Diode, 1S1588 or (HV-80)
D22	8000-00028-267	Diode, 1S1588 or (HV-80)
D23	8000-00028-267	Diode, 1S1588 or (HV-80)
D24	8000-00048-020	Diode, FC52M
D25	8000-00048-020	Diode, FC52M
D26	8000-00038-018	Diode, MV201 or (T18)
D27	Not used	
D28	8000-00028-267	Diode, 1S1588 or (HV-80)
D301	8000-00048-201	Diode, EQA01-11R
D302	8000-00048-022	Diode, ERC01-02/GP-30
D303	8000-00028-267	Diode, 1S1588 or (HV-80)
D401	8000-00028-267	Diode, 1S1588 or (HV-80)
D402	8000-00006-007	Diode, 1N60
D403	8000-00028-267	Diode, 1S1588 or (HV-80)

SYMBOL #	PART #	DESCRIPTION
D404	8000-00028-267	Diode, 1S1588 or (HV-80)
D405	8000-00028-267	Diode, 1S1588 or (HV-80)
D406	8000-00006-007	Diode, 1N60
D407	8000-00028-267	Diode, 1S1588 or (HV-80)
D408	8000-00048-023	Diode, I.T.T. 310
D409	8000-00048-023	Diode, I.T.T. 310
D410	8000-00006-007	Diode, 1N60
D501	8000-00048-024	LED, TLG-103
D502	8000-00048-025	LED, TLR-104
DS1	8000-00003-066	Ceramic Disc., 455D
FL1	8000-00048-074	Crystal Filter
FL2	8000-00048-075	Ceramic Filter, LF-C15
J1	8000-00048-091	Ant. Connector Jack, Y-R-NEW
J2	8000-00048-092	Power Connector Jack, FS214-2MSS
J3	8000-00048-093	Jack, 3.5Ø, SG-8022
J4	8000-00048-093	Jack, 3.5Ø, SG-8022
J7	8000-00004-070	Mic. Jack, FM214-4S
L1	8000-00048-054	Air Coil, 8LNC-112
L2	8000-00048-054	Air Coil, 8LNC-112
L3	8000-00048-055	Choke Coil, 4LNC-111, 1µH
L4	8000-00048-056	Air Coil, 4.5LNC-113
L5	8000-00048-057	Air Coil, 4.5LND-115
L6	8000-00048-058	Air Coil, 4.5LND-114
L7	8000-00048-059	Coil, GR-512
L8	8000-00048-060	Coil, GR-526
L9	8000-00048-061	Coil, GR-513
L10	8000-00048-062	Coil, GR-510
L11	8000-00048-063	Coil, GR-511
L12	8000-00048-061	Coil, GR-513
L13	8000-00048-061	Coil, GR-513
L14	8000-00048-060	Coil, GR-526
L15	8000-00048-061	Coil, GR-513
L16	8000-00048-064	Coil, GR-506
L17	8000-00048-065	Coil, GR-514
L18	8000-00048-065	Coil, GR-514
L19	8000-00048-066	Coil, GR-508
L20	8000-00048-067	Coil, GE-K-536
L21	8000-00048-068	Coil, GR-516
L22	8000-00048-059	Coil, GR-512
L23	8000-00048-059	Coil, GR-512
L24	8000-00048-069	Choke Coil, 5LNC-118
L25	8000-00048-069	Choke Coil, 5LNC-118
L401	8000-00048-062	Coil, GR-510
L402	8000-00048-070	Coil, GR-507
LM301	8000-00048-090	Lamp
LM302	8000-00048-090	Lamp

SYMBOL #	PART #	DESCRIPTION
LM303	8000-00048-090	Lamp
LM304	8000-00048-090	Lamp
Q1	8000-00048-001	Transistor, MRF238
Q2	8000-00048-002	Transistor, 2N6080
Q3	8000-00048-003	Transistor, 2N4427
Q4	8000-00048-003	Transistor, 2N4427
Q5	8000-00048-004	Transistor, 2SC710(C)
Q6	8000-00011-053	F.E.T., 3.5SK45
Q7	8000-00011-047	Transistor, 2SC710(C)
Q8	8000-00011-047	Transistor, 2SC710(C)
Q9	8000-00028-038	Transistor, 2SC735 (Y)
Q10	8000-00048-005	Transistor, 2SC496(Y)
Q11	8000-00006-280	Transistor, 2SC1364
Q12	8000-00028-039	Transistor, 2SC1173(O)
Q13	8000-00048-005	Transistor, 2SC496(Y)
Q14	8000-00048-005	Transistor, 2SA49S(Y)
Q15	8000-00006-280	Transistor, 2SC1364
Q16	8000-00047-055	Transistor, 2SA844D
Q17	8000-00006-280	Transistor, 2SC1364
Q18	8000-00006-280	Transistor, 2SC1364
Q19	8000-00006-280	Transistor, 2SC1364
Q20	8000-00006-280	Transistor, 2SC1364
Q21	8000-00028-038	Transistor, 2SC735(Y)
Q22	8000-00011-050	Transistor, 2SC1061
Q23	8000-00048-007	F.E.T., 3SK48
Q24	8000-00011-053	F.E.T., 3SK45
Q25	8000-00006-280	Transistor, 2SC1364
Q26	8000-00006-280	Transistor, 2SC1364
Q27	8000-00006-280	Transistor, 2SC1364
Q28	8000-00006-280	Transistor, 2SC1364
Q29	8000-00006-280	Transistor, 2SC1364
Q30	8000-00048-008	IC, TA 7027
Q31	8000-00048-008	IC, TA 7027
Q32	8000-00011-047	Transistor, 2SC710(C)
Q33	8000-00011-047	Transistor, 2SC710(C);
Q34	8000-00028-048	Transistor, 2SA473(O)
Q35	8000-00028-039	Transistor, 2SC1173(O)
Q36	8000-00028-038	Transistor, 2SC735(Y)
Q37	8000-00006-280	Transistor, 2SC1364
Q38	8000-00048-009	IC, TA 7063
Q39	8000-00048-010	IC, TA 7060
Q40	8000-00006-280	Transistor, 2SC1364
Q41	8000-00011-047	Transistor, 2SC710(C)
Q42	8000-00011-047	Transistor, 2SC710(C)
Q43	8000-00048-004	Transistor, 2SC383(Y)
Q44	8000-00006-280	Transistor, 2SC1364
Q401	8000-00048-011	IC, TA 78005P / LM 340T-5
Q402	8000-00048-012	93S16
Q403	8000-00048-013	74S05
Q404	8000-00038-004	SN 7400
Q405	8000-00038-007	SN 7474

SYMBOL #	PART #	DESCRIPTION
Q406	8000-00048-014	IC, NC 6400
Q407	8000-00006-280	Transistor, 2SC1364
Q408	8000-00006-280	Transistor, 2SC1364
Q409	8000-00006-280	Transistor, 2SC1364
Q410	8000-00047-055	Transistor, 2SA844D
Q411	8000-00011-047	Transistor, 2SC710(C)
Q412	8000-00011-047	Transistor, 2SC710(C)
Q413	8000-00048-015	IC, LM 741CH
Q414	8000-00011-047	Transistor, 2SC710(C)
Q415	8000-00011-047	Transistor, 2SC710(C)
Q416	8000-00011-047	Transistor, 2SC710(C)
Q417	8000-00011-047	Transistor, 2SC710(C)
Q501	8000-00038-004	IC, SN 7400
Q502	8000-00038-004	IC, SN 7400
Q503	8000-00006-280	Transistor, 2SC1364
Q504	8000-00006-280	Transistor, 2SC1364
Q505	8000-00047-055	Transistor, 2SA844D
Q506	8000-00047-055	Transistor, 2SA844D
Q507	8000-00048-016	Transistor, 2SC509(O)
Q508	8000-00048-016	Transistor, 2SC509(O)
Q509	8000-00048-017	LED, 5082-7650
Q510	8000-00048-017	LED, 5082-7650
SW302	8000-00048-083	Switch, J-T3100
SW303	8000-00048-083	Switch, J-T3100
SW304	8000-00048-084	Switch, J-T3200
TH1	8000-00048-026	Thermistor, S5C-23
TP1-9	8000-00048-086	Test Pin
VR1	8000-00048-079	Potential Meter, 50K
VR2	8000-00048-080	Potential Meter, 2K
VR3	8000-00006-046	Potential Meter, 5K
VR4	8000-00004-096	Potential Meter, 10K
VR5	8000-00006-046	Potential Meter, 5K
VR6	8000-00011-082	Potential Meter, 1K
VR301	8000-00048-081	Volume, VM11A-5M112-10KD
VR302	8000-00048-082	Volume, VM10A-10KB
VR303	8000-00048-082	Volume, VM10A-10KB
X1	8000-00048-076	Crystal, HC18U, 12.3 MHz
X2	8000-00048-077	Crystal, HC18U, 16.9 MHz
X3	8000-00048-078	Crystal, HC18U, 17.355 MHz
X401	8000-00048-150	Crystal, HC18U, 10.24 MHz
MISCELLANEOUS		
	8000-00048-094	Power Plug, FM142M
	8000-00048-095	Speaker, 8Ω, 1W, 92Ø
	8000-00048-096	Heat Sink, 21-3A-840
	8000-00048-097	Display Connector

SYMBOL #	PART #	DESCRIPTION
	8000-00048-098	Display Pin Connector, 5047-13
	8000-00048-099	Keyboard Connector
	8000-00048-100	Fuses, 7A
	8000-00048-101	Power Cable
	8000-00048-102	Miniature Phone Plugs, PN-8 BLACK
	8000-00048-103	Meter
	8000-00048-104	Main P.C.B.
	8000-00048-105	Sub P.C.B.
	8000-00048-106	Screw, 1 Kit
	8000-00048-107	IC Socket, D1CA-28C-T1-28P
	8000-00048-108	IC Socket, D1CA-KIC-T1-14P
	8000-00048-109	IC Socket, D1CA-16C-T1-16P
	8000-00048-110	Wire, 1 Kit
	8000-00048-111	Micro Phone
	8000-00024-204	Mic. Hanger
	8000-00048-112	Mounting Bracket
	8000-00048-113	Thumb Screws
	8000-00048-114	ANT. Lug
	8000-00048-115	FCC Lable
	8000-00048-116	Dress Box
	8000-00048-117	Front Chassis
	8000-00048-118	Side Chassis (Right)
	8000-00048-119	Side Chassis (Left)
	8000-00048-120	PLL Shild Case
	8000-00048-121	PLL Shild Cover (Top)
	8000-00048-122	PLL Shild Cover (Bottom)
	8000-00048-123	Bonnet (Top)
	8000-00048-124	Bonnet (Bottom)
	8000-00048-125	Handle Bracket
	8000-00048-126	Meter Bracket
	8000-00048-127	Heat Sink (A)
	8000-00048-128	Feed Thru Cap. Holder
	8000-00048-129	Speaker Bracket (A)
	8000-00048-130	Chemical Cap. Holder
	8000-00048-114	Earth Lug
	8000-00048-132	Heat Sink (B)
	8000-00048-133	Bezel
	8000-00048-134	LED Spacer
	8000-00048-135	Volume Knob
	8000-00048-136	Front Panel
	8000-00048-137	Face Plate
	8000-00048-138	Speaker Himelon
	8000-00048-139	Meter Pad
	8000-00048-140	PLL Shild Fiber
	8000-00048-141	Pole Case
	8000-00048-142	Handle Screw
	8000-00048-143	Speaker Bracket (B)
	8000-00048-144	Speaker Jack Cap
	8000-00048-145	Mic. Jack Spacer
	8000-00048-146	Speaker Spacer
	8000-00048-147	Heat Sink Sponge (A)
	8000-00048-148	Heat Sink Sponge (B)
	8000-00048-149	Lever Switch Pad
	8000-00048-131	Styrofoam Box
	8000-00048-085	Key Board

